

**Juicy**  
S E V E N™



**Quick Install and Set-Up Guidelines**

**IMPORTANT**

Brakes are a safety-critical item on a bicycle. Improper set-up or use of brakes can result in loss of control or an accident, which could lead to a severe injury.

Avid brakes are a performance product that offer increased stopping power over brakes that you may be used to. This greater power requires less effort to lock-up a wheel when braking. A wheel lock-up might cause you to lose control and possibly cause injury.

It's your responsibility to learn and understand proper braking techniques. Consult the owner's manual for your bicycle and a professional bike dealer. Practice your riding and braking techniques on a flat and level surface prior to aggressive riding.

The effectiveness of braking is dependent on many conditions over which Avid has no control. These include the speed of the bicycle, type and condition of the riding surface, braking lever force, proper installation and maintenance of brakes, brake lines, hydraulic fluid, levers, brake pads, the condition of the bike, weight of the rider, proper braking techniques, weather, terrain, and a variety of other factors.

Avid brakes and levers are not intended for use on any motorized bicycle or vehicle. Any such use could result in a serious personal injury.

**ALWAYS RIDE UNDER CONTROL**

Remember, it takes longer to stop in wet conditions. To reduce the possibility of an accident and minimize trail erosion, you should avoid locking-up your wheels.

Juicy Disc Brakes are designed as a system. **DO NOT USE COMPONENTS FROM A MANUFACTURER OTHER THAN AVID WITHIN THE SYSTEM.**

Avid Disc Brake Rotors are compatible with 44mm, 6-bolt International Standard disc hubs.

We recommend 32 or 36 spoke wheels with a 3 or 4 cross spoke lacing pattern. **DO NOT USE RADIALY SPOKED WHEELS.**

**FOR BEST RESULTS** only use Avid Hi-Performance DOT Fluid with Juicy Disc Brakes.

**IF AVID FLUID IS NOT AVAILABLE** only use DOT 4 or DOT 5.1 Fluid

**DO NOT USE A FLUID OTHER THAN THE DOT FLUIDS SUGGESTED. DOING SO WILL DAMAGE THE SYSTEM AND MAKE THE BRAKES UNSAFE TO USE.**

**DOT FLUIDS WILL DAMAGE PAINTED SURFACES. IF ANY FLUID COMES IN CONTACT WITH A PAINTED SURFACE (i.e. your frame), WIPE IT OFF IMMEDIATELY AND CLEAN WITH ISOPROPYL ALCOHOL.**

**DO NOT ALLOW ANY BRAKE FLUID TO COME IN CONTACT WITH THE BRAKE ROTORS. IF THIS OCCURS, CLEAN THE ROTORS WITH ISOPROPYL ALCOHOL.**

**DO NOT ALLOW ANY BRAKE FLUID TO COME IN CONTACT WITH THE BRAKE PAD FRICTION MATERIAL. IF THIS OCCURS, THE PADS ARE CONTAMINATED AND MUST BE REPLACED.**

**WARNING**

Wear gloves, or handle the rotor by the spokes. **DO NOT TOUCH THE BRAKING SURFACE OF THE ROTOR WITH YOUR BARE HANDS. OILS FROM YOUR FINGERS WILL DEGRADE THE PERFORMANCE OF ANY DISC BRAKE.**

Disc brakes become very hot during use. **DO NOT TOUCH THE CALIPER OR ROTOR IMMEDIATELY AFTER USE. MAKE SURE THE BRAKE HAS COOLED DOWN BEFORE MAKING ANY ADJUSTMENTS.**

**TRI-ALIGN™ CALIPER POSITIONING SYSTEM™**

Avid Disc Brakes use a unique alignment system called Caliper Positioning System (CPS). The stacks of concave and convex washers allow the caliper to be perfectly aligned with the rotor, regardless of imperfections in the mounting tabs on the fork or frame, giving you full, square pad contact.

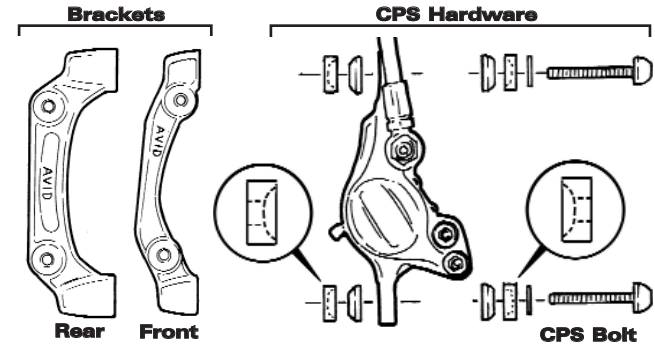

**BREAKING IN THE PADS**

It may take anywhere from 20 to 40 complete stops to break in Avid pads. You may begin to notice an increase in braking power after the first ride. Brake noise can occur not only during the break-in period, but off and on throughout the life of the brake pads. Noise is dependent upon factors such as brake set-up, rider weight, riding style, braking style, and riding conditions (i.e. dust, soil, etc. contamination of friction surfaces).

**ABOUT BRAKE ROTOR FLATNESS**

Brake rotors are thin. Any brake rotor can bend or warp over time, or maybe even be slightly off out of the box. To fix a slight wobble, identify whether the rotor is bumping on the inboard or outboard pad. Once the bad spot is located, put on some gloves or cover the spot with a clean rag and tweak it back into position by hand. **NEVER TOUCH A ROTOR WITH YOUR BARE HANDS!**

Juicy01-11/03

**Juicy QUICK INSTALL**

**TOOLS YOU WILL NEED:** 2mm, 4mm, and 5mm hex wrenches, T-25 TORX® wrench, 8mm open-end wrench, adjustable torque wrench [2.8-10Nm (25-90 IN-Lbs) range].

**1**

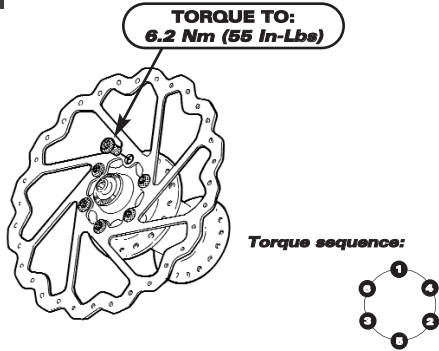

**INSTALL THE ROTOR**

Mount the rotor to the hub using the supplied T-25 TORX® bolts and tighten to the specified torque. **AVID logo MUST face out.** Install the wheel into the fork or frame.

**IMPORTANT:** The supplied TORX® wrench is for emergencies only. Use a torque wrench to ensure proper torque value.

**2**

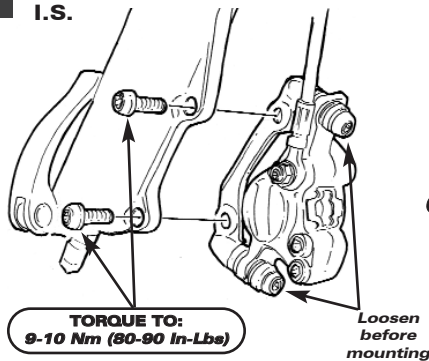

**MOUNT THE FRONT CALIPER**

Mount the front caliper (shorter hose) to the fork.

**For I.S. mount,** loosen the CPS bolts, then bolt the caliper to the mounting tabs. Tighten the mounting bolts to the specified torque. Check that the caliper moves freely on the CPS hardware.

**OR**

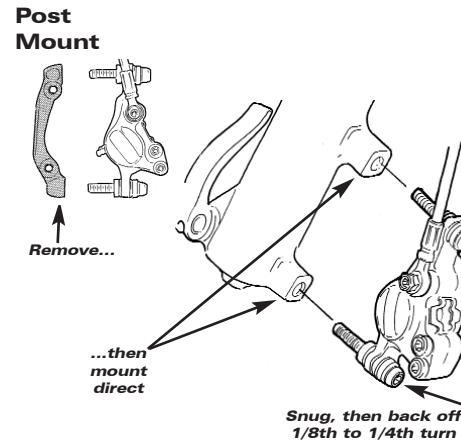

**For Manitou Post Mount,** remove the mounting bracket but leave the CPS bolts and washer stacks in tact. Bolt the caliper directly to the fork. Snug the bolts, then back them out 1/8th to 1/4th turn. Check that the caliper moves freely on the CPS hardware.

**3**

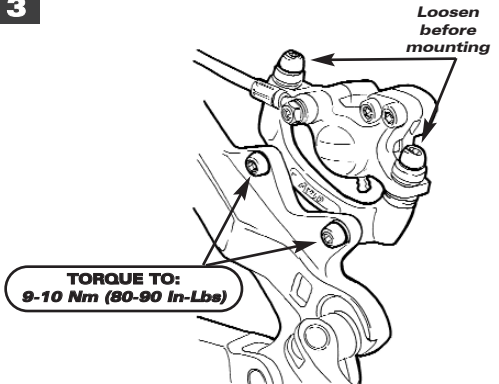

**MOUNT THE REAR CALIPER**

Loosen the CPS bolts, then mount the rear caliper (longer hose) to the I.S. tabs on the rear of the bike. Tighten the mounting bolts to the specified torque. Check that the caliper moves freely on the CPS hardware.

4

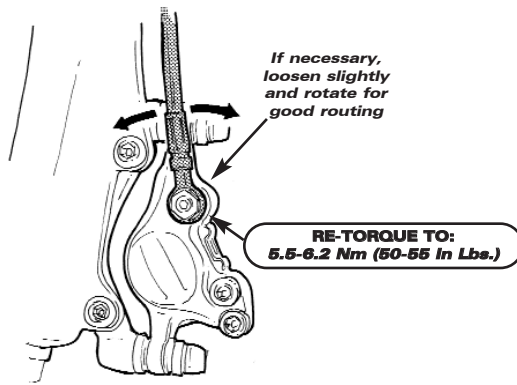

#### ADJUST THE HOSE ANGLES, THEN ROUTE THE HOSES

If necessary, slightly loosen the banjo bolts on the calipers with an 8mm open-end wrench and rotate the fittings for optimal routing. Be sure to loosen the banjos just enough to rotate the fittings, but not enough to let air into the system. Re-tighten the banjo bolts to the specified torque, then route the hoses. After checking that there is enough hose at critical points to allow for suspension movement, secure the hoses to the frame and fork.

6

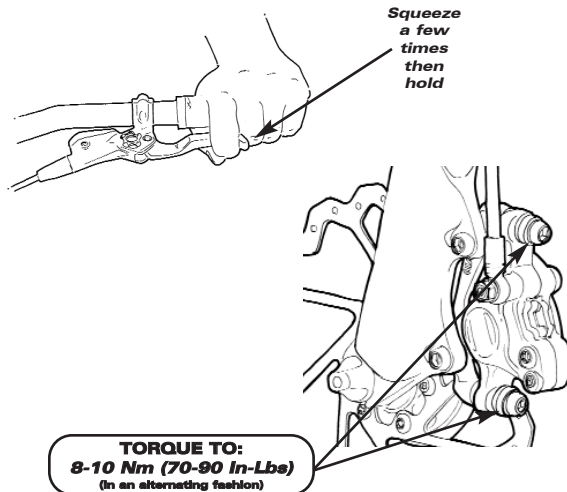

#### ALIGN THE CALIPERS

**WARNING:** Failure to tighten the CPS bolts in the following manner can damage the caliper and make it unsafe to ride.

Squeeze the lever 5 or 6 times, then squeeze and hold. While holding the lever, lightly snug the CPS bolts to hold the caliper in place. Spin the wheel and check for rotor drag. If there is drag, loosen the CPS bolts and repeat. Once there is no drag, gradually tighten the bolts, alternating from one bolt to the other, steadily increasing force until each bolt is at the specified torque. Repeat for the rear brake.

5

Mount levers with arrows and Avid facing up (or forward)



Check that the bars turn freely

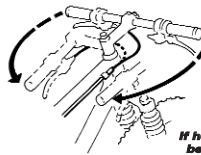

**Note:** If hoses need to be shortened, the Avid Bleed Kit is required. Contact your local bike shop for this kit.

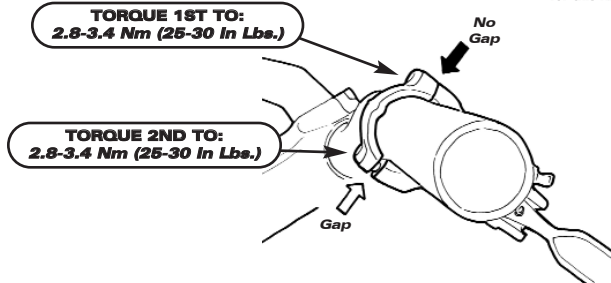

#### MOUNT THE LEVERS

Mount the levers onto the bar in the proper position. Avid logo and arrow must point up. Make sure there is enough hose for the handlebar to turn freely side to side. **Tighten the top bolt completely** to the specified torque so there is no gap. Tighten the bottom bolt to the same torque.

**NOTE:** Shortening hoses requires the Avid bleed kit.

7

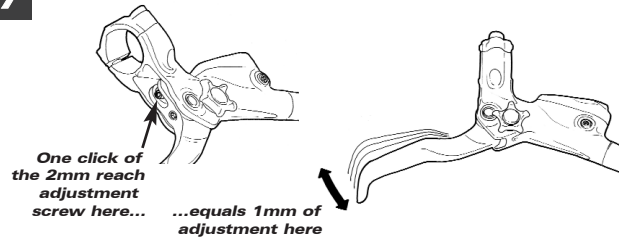

#### ADJUST THE REACH

Use a 2mm hex wrench to adjust the reach if necessary. One click equals 1mm of adjustment.

**NOTES FOR GRIPSHIFT USERS ONLY - VERY IMPORTANT:** It will be necessary to slide the levers away from the shifters or remove them completely to access the reach adjustment screw.

Please note that the reach adjustment screw changes position when the Pad Contact Point Knob is turned. Because of this, be sure that when the lever is released there is plenty of clearance between the lever, the reach adjust screw, and the side of the shifter. This clearance should be checked after every adjustment of the Pad Contact Point. **ALSO** make sure that when the lever is engaged it is not contacting the front of the shifter.

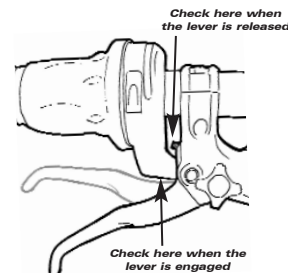

5a (optional)

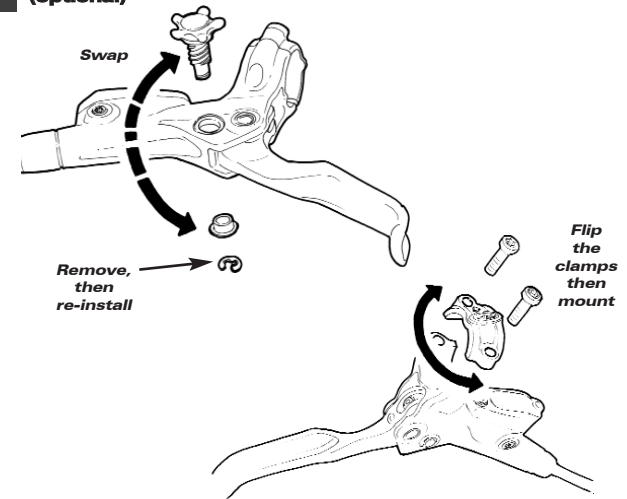

#### RIGHT-HAND FRONT SWAP (optional)

To run moto-style (right-hand front), remove the E-Clip from the bottom of the pivot assembly. Then remove the Speed Dial Knob, remove the bushing, and swap. Replace the E-Clip. Repeat for the other lever. Flip the clamps over so the Avid logos and arrows face up, then mount as in Step 5.

8

Turn knob in the direction of lever travel to move pad contact point in toward handlebar

Free travel can be adjusted within the range shown:

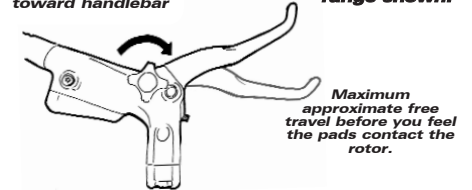

Turn knob opposite of lever travel to move pad contact point out away from handlebar

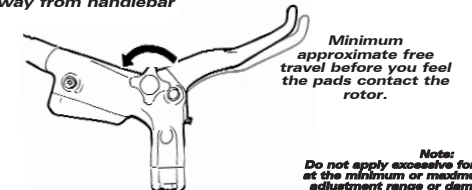

**Note:** Do not apply excessive force to the knob at the minimum or maximum stops of the adjustment range or damage can occur that is not covered by warranty.

#### ADJUST THE PAD CONTACT POINT

This exclusive Avid feature lets you choose how much free travel your lever has before the pads contact the rotor. Turning the Pad Contact Point Knob in the direction of lever travel intuitively moves the contact point in (toward the bar), while turning it the opposite direction moves the contact point out (away from the bar).

**NOTE:** The pad to rotor clearance doesn't change when making this adjustment.

**RIDE!**